

**Herd**

# SURE-FEED BROADCASTER

**Instructions for  
ASSEMBLY, MOUNTING,  
BROADCASTING, OPERATING and  
MAINTENANCE**

**Herd**

**MODEL GT-77  
FOR ATV'S**

**REPAIR PARTS LIST**



## **HERD SEEDER COMPANY, INC.**

P.O. Box 448 • 2383 South U.S. 35  
Logansport, IN 46947  
Phone: 574-753-6311 • Fax: 574-722-4106  
Email: [info@herdseeder.com](mailto:info@herdseeder.com)  
[www.herdseeder.com](http://www.herdseeder.com)

# Herd

## MODEL GT-77

For ATV's

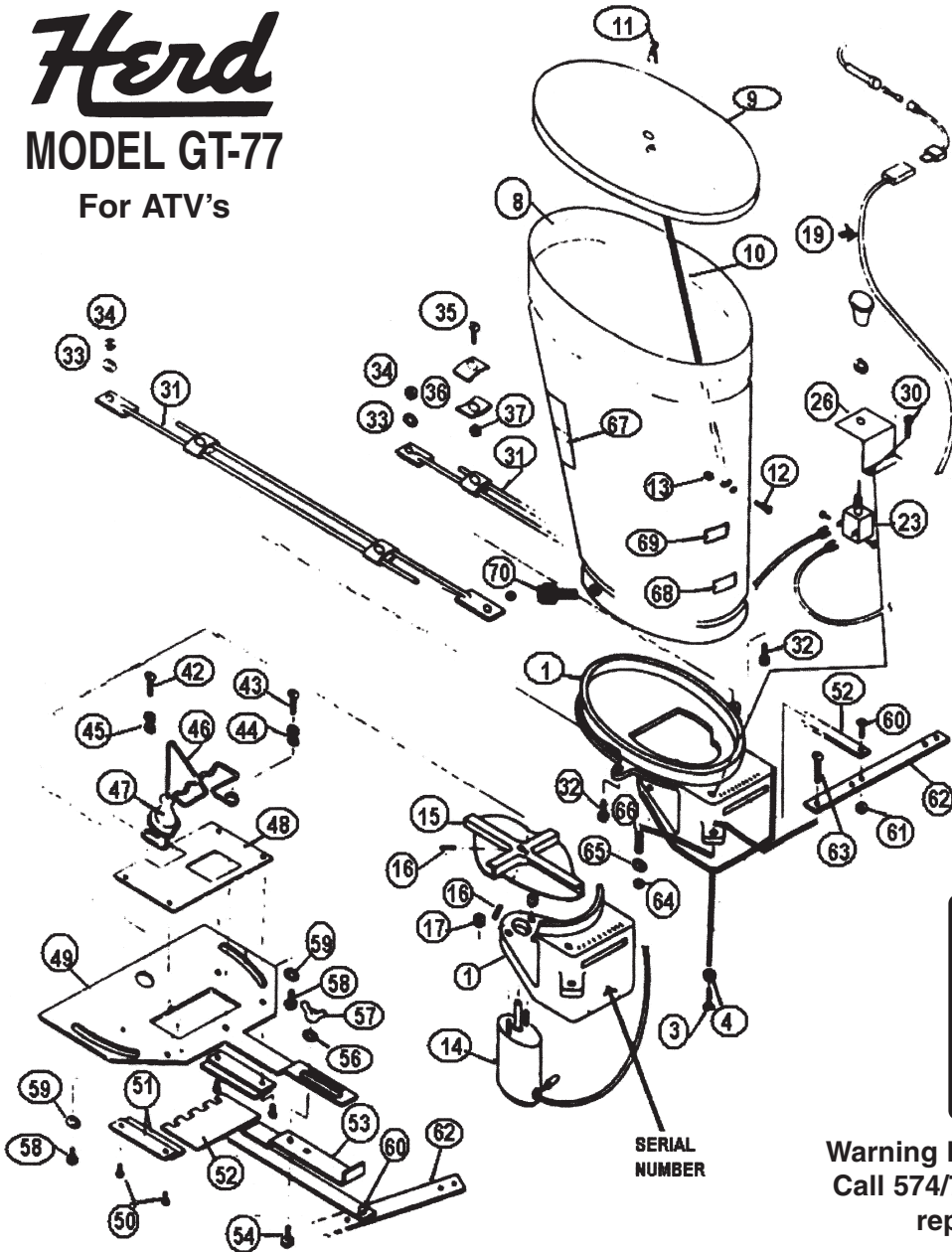

**Warning Decal - If missing  
Call 574/753-6311 for free  
replacement.**



**“CAUTION”** KEEP HANDS, FINGERS AND LOOSE CLOTHING WELL AWAY FROM SPINNING FAN OR INJURY MAY RESULT.

For your own record fill in the following:

Date Purchased \_\_\_\_\_ Serial Number \_\_\_\_\_

Purchased From \_\_\_\_\_ Model Number \_\_\_\_\_

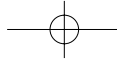

PARTS and ACCESSORIES FOR MODEL GT-77 BROADCASTER for A.T.V.'s

Shown in Drawing

When ordering parts, order by both part name and number ... not drawing number.

<u>Drawing Number</u>	<u>Part Number</u>	<u>Name of Part</u>	<u>Number Needed</u>
1.	500	Grey-Iron Base for GT-77.....	1
3. & 4.	410A	1/2" x 1" Hexhead Capscrew w/Lock Washer.....	2
8.	911	Hopper Complete with Screws & Decals .....	1
9. & 11.	912	Lid w/Cotter Key .....	1
10.,12.,13.	913	Lid Spring w/Screw, Washer & Nut .....	1
14.	778	12-Volt Motor w/Whiz Nuts (#779).....	1
15.	501	Fan 4-Bladed (Plastic), 5/16" Shaft Hole, w/St. St. Setscrews ....	1
16.	502	1/4" x 3/8" Socket Screw, S.S. (Included with 501 Fan) .....	2
17.	779	Whiz Nut (10-32) - Used on Motor .....	2
19.	812	Complete Wiring Assembly .....	1
23.	794	Push-Pull Switch .....	1
26.	541	Switch Bracket .....	1
30.	107	1/4" x 1/2" Hex Head Cap Screw .....	1
31.	512	Brace Rod - 5/16" Hole in End (Used on Carton "D" only) .....	4
32.,33.,34.	407	5/16" x 1" Machine Bolt w/Nut and Lock Washer .....	2
35.,36.,37.	924	Brace Rod Clamp, Complete (Used on Carton "D" only) .....	2
42.	781	Round Head Machine Screw, Left-Hand Thread - Used to Bolt Bronze Bushing to Fan .....	1
43.	507	3/16" x 3/8" Round-head Machine Screw, St. St., w/Washer.....	1
44. & 45.	503	Bronze Agitator Bushing - Used on Fan & Pivot Plate .....	2
46.	209	Vibrating Agitator - Stainless Steel .....	1
47.	508L	Nipple - Used on Agitator .....	1
48.	*517	Blocking Plate - Optional (Must be purchased separately).....	1
49.	802S	Pivot Plate - Stainless Steel .....	1
50.	510	3/16" x 3/8" Round-head Machine Screw, St. St. ....	4
51.	509	Guide Assemblies for Seed Gate (1 Set Consists of 2) - Stainless Steel .....	2 Sets
52.	504	Opening Plate w/Connecting Linkage - St. St.....	1
53.	803S	Opening Gauge Control Plate w/515 Carriage Bolt, Wing Nut and Washer - Works with Pivot Plate 802S - Stainless Steel .....	1
54.			
56. & 57.	515	1/4" x 1/2" Carriage Bolt, St. St. - w/Wing Nut & Washer.....	1
58. & 59.	516	1/4" x 1/2" Hexhead Capscrew, St. St. - w/Washer .....	2
60. & 61.	505	1/4" x 1/2" Pan Head Bolt, St. St. - w/Locking Nut.....	1
62.	792	Control Handle .....	1
63.,64.,65.	806A	3/16" x 1-3/4" Machine Screw, w/Nut & Washer.....	1
66.	807	Compression Spring - Used on Handle Bolt.....	1
67.	831	"HERD Sure-Feed Broadcaster" Decal .....	1
68.	210	Decal - Model GT-77 .....	1
69.	1091	"WARNING" Spinning Blades Decal.....	1
70.	408A	#10 x 3/4" Phillips Truss Head Machine Screw w/Nut .....	4
	511	Stand (Supplied with Mounting Carton D, JD-1 and U only) (Not Shown)	1
	514B	1/2" x 1-3/4" Hexhead Capscrew, Lock Washer & Nut (Not Shown)	1

\*Special blocking plates available for fire ant baits. Call factory for details.

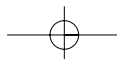

### ASSEMBLY INSTRUCTIONS FOR ALL A.T.V.'S.:

1. Take broadcast seeder GT-77 from carton and place it upside down on the hopper.
2. Rotate handle around and remove bolt and self-locking nut. Run bolt through seed-gate linkage, then through the handle, making sure that the thread end is pointing up, toward you. Replace self-locking nut. Do not over-tighten, as it must pivot at this point.
3. Remove the two 1/2" bolts from the grey-iron base part number 500 and keep these for mounting of ATV mounting brackets.
4. Follow the supplemental instructions for mounting the GT-77 seeder to your specific A.T.V.

### WIRING INSTRUCTIONS

1. Be safe! Disconnect ground wire from battery before wiring.
2. Connect the short line with the fuse (20 Amp) in the line to the battery on the positive (+) side.
3. Be sure to replace safety cap over battery terminal, if one is furnished.
4. Connect forked end of long wire to either terminal on switch. Connect female end to male end of "Quick- Connector" on fuse line.
5. Connect orange wire from motor to other terminal on switch.
6. The black wire on the motor is the ground. Make sure it is connected to the bottom of the motor. It is best to run a ground wire from the battery to any part of the frame or seeder. If that does not work, splice into the ground (black wire) on the motor to the battery ground.
7. Reconnect vehicle ground to battery.
8. Same as #5.

### CLEANING AND STORAGE OF BROADCASTER

After removing the broadcaster from the A.T.V., turn it upside-down on the hopper, so that all material remaining in the hopper is removed. Then wipe or brush out any remaining material. If compressed air is available, use it to blow off any residue from the broadcaster and the electric motor. The electric motor is sealed and does not require any maintenance, other than removing any external residue.

If the broadcaster is used to spread corrosive material like fertilizer or ice melter, wiping a fine film of oil on the working parts will keep them working free in the future. The pivot plate and all the parts attached to it are made of stainless steel and are rust-resistant for years of life.

The fused end of the "Quick-Connect" battery lead may be left on the A.T.V. for future use but be sure to disconnect the wiring harness at the disconnect socket and not at the fuse holder.

The broadcaster should be stored in a dry storage area when not in use. High moisture areas will cause condensation internally to the motor and will significantly shorten the motor life.

HERD SEEDER COMPANY, INC., LOGANSPOUT, IN 46947

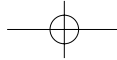

### TIPS FOR USING BROADCASTERS

1. **WATCH YOUR SPEED!** Do Not Go Too Fast For Conditions. If Ground Is Rough, Cut Your Speed. Remember when seeder is loaded it causes much strain on A.T.V.s and hitch brackets when you start bouncing through holes and rough ground. The hitches were designed for normal usage, so do not get carried away and go too fast.
2. As is common with all broadcast seeders, do not use on windy days as this will cause erratic spread, especially with herbicides and may cause damage to crops in nearby fields.
3. If your equipment (or vehicle) has a battery and charging system, keep your R.P.M.s sufficiently high enough to charge at all times.
4. The easy way to determine the ground speed of your A.T.V. or tractor is to set two stakes in the ground, 88 feet apart, and check with the chart below.

At 2 M.P.H. you will travel 88 ft. in 30 seconds  
 At 3 M.P.H. you will travel 88 ft. in 20 seconds  
 At 4 M.P.H. you will travel 88 ft. in 15 seconds  
 At 6 M.P.H. you will travel 88 ft. in 10 seconds  
 At 8 M.P.H. you will travel 88 ft. in 7 1/2 seconds

5. After determining the gear and throttle settings of the A.T.V. mark the settings so the throttle can be returned to the proper location when broadcasting.
6. This broadcaster is equipped with a centering pivot plate, which can be moved to center the spread of material. To change location, loosen two capscrews holding pivot plate to bottom of base and move it to a higher or lower letter by taking hold of the seed gauge and moving as explained in next step. A good starting point is to move the seed gauge to the letter "C" for most Clover, Alfalfa and Fertilizers.
7. If you see your spread is heavy on one side or the other, after you start to spread, do the following to center the pattern of spread: (You distinguish the difference between right and left by standing behind the A.T.V. or tractor and broadcaster and facing the direction the A.T.V. or tractor will travel.)
  - (a) When the pattern of spread is off-center to your right, move the pivot plate to a lower letter.
  - (b) If your spread is off-center to your left, move the pivot plate to a higher letter.
  - (c) Do not move over one letter at a time or you may over-correct.

### INSTRUCTIONS FOR INSTALLING OPTIONAL BLOCKING PLATE 517

1. Loosen two capscrews holding pivot plate to base and center pivot plate.
2. Remove pivot screw and bushing in pivot plate that anchors agitator to pivot plate. Slide the blocking plate under agitator and over the four protruding screws, making sure that protrusion lays down in opening of pivot plate and blocking plate is flat against pivot plate.
3. Replace pivot screw and bushing. Tighten but do not over-tighten. If it is over-tightened, end of screw will extend through pivot plate in bottom and block movement of opening plate.

HERD SEEDER COMPANY, INC., LOGANSPORT, IN 46947

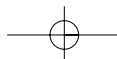

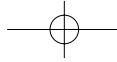

### TO REPLACE VIBRATOR BUSHING ON FAN

1. Remove nipple from pivot plate hole.
2. Remove round head machine screw and bushing holding agitator to pivot plate.
3. Move agitator forward and at the same time, turn fan so that agitator can be removed from bushing on top of fan.
4. Remove agitator from opening.
5. Turn fan so that bushing and round-head screw can be removed through opening
6. Remove bushing from fan by the following: This round-head machine screw is left-hand threaded, so turn right to loosen.
7. Replace new bushing. Tighten the left-hand screw tight.
8. Replace agitator through opening, positioning agitator on fan by turning fan so the bushing is placed between forks on agitator.
9. Replace bushing and round-head machine screw that holds agitator to pivot plate.
10. Replace nipple in round opening.

### TO REPLACE NIPPLE

1. Remove nipple from pivot plate hole.
2. Remove round-head machine screw and bushing holding agitator to pivot plate.
3. Move agitator forward and at the same time, turn fan so that agitator can be removed from bushing on top of fan.
4. Remove agitator from opening.
5. Remove nipple from agitator.
6. Install new nipple on agitator. (A little moisture on nipple where agitator goes through will ease the operation.)
7. Replace agitator through opening, positioning agitator on fan by turning fan so the bushing is placed between forks on agitator.
8. Replace bushing and round-head machine screw that holds agitator to pivot plate.
9. Replace nipple in pivot hole.

### TROUBLE SHOOTING

If motor will not run, turn switch to "Off" position and turn motor by hand to be sure that it turns freely. Check **ground**, check fuse (this is a 20-amp fuse), check battery connections and battery, and then turn switch to "On" position. The unit should run if the motor is not damaged. For erratic spread of fertilizer or insecticides, check for lumps in material.

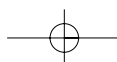

**CHART FOR HERD BROADCASTER**  
**GT-77**

(Electric Motor Powered-Full Speed on 12 Volts)

<u>Material</u>	<u>Spread Width</u>	<u>Amount Per Acre</u>	<u>Opening Width</u>	<u>Speed MPH</u>	<u>Time Required Per Acre</u>
Clover, Alfalfa, and Sweet Clover	28'	10#	1/8"	4	4 Min. 25 Sec.
	28'	6.6#	1/8"	6	2 Min. 57 Sec.
	28'	5#	1/8"	8	2 Min. 13 Sec.
Bermuda Grass (Hulled) Set Base on H	22'	9#	1/8"	6	3 Min. 45 Sec.
	22'	6-3/4#	1/8"	8	2 Min. 49 Sec.
	22'	5.4#	1/8"	10	2 Min. 15 Sec.
Kentucky Blue Grass	8'	23#	5/16"	4	15 Min. 28 Sec.
	8'	15-1/2#	5/16"	6	10 Min. 19 Sec.
	8'	11-12#	5/16"	8	7 Min. 44 Sec.
Rye Grass & Red Fescue	14'	22#	7/8"	4	8 Min. 50 Sec.
	14'	14-3/4#	7/8"	6	5 Min. 54 Sec.
	14'	11#	7/8"	8	4 Min. 25 Sec.
Red Top	10'	17#	1/4"	4	12 Min. 23 Sec.
	10'	11#	1/4"	6	8 Min. 15 Sec.
	10'	8-1/2#	1/4"	8	6 Min. 11 Sec.
Highland Bent	10'	18-1/2#	3/8"	4	12 Min. 23 Sec.
	10'	12#	3/8"	6	8 Min. 15 Sec.
	10'	9.2#	3/8"	8	6 Min. 11 Sec.
Switch Grass	24'	5#	1/16"	10	2 Min. 4 Sec.
Fertilizer	24'	62#	5/8"	4	5 Min. 9 Sec.
	24'	41#	5/8"	6	3 Min. 26 Sec.
	24'	31#	5/8"	8	2 Min. 35 Sec.
Nitrogen (Pelleted 45% Urea)	18'	82#	5/8"	4	6 Min. 53 Sec.
	18'	55#	5/8"	6	4 Min. 35 Sec.
	18'	41#	5/8"	8	2 Min. 35 Sec.

**CHART FOR BROADCASTING SEEDS AND FERTILIZER - MODEL GT-77**  
**FIGURED AT 4 M.P.H.**

<u>SEED OR MATERIAL</u>	<u>SIZE OPENING</u>	<u>SOWS PER ACRE</u>	<u>WIDTH</u>
Ammonium Nitrate .....	3/8"	8 LBS.	24 FT.
Australian Pea.....	3/8"	60 LBS.	34 FT.
Bahia Grass .....	3/16"	19 LBS.	18 FT.
Brome Grass .....	1/2"	11-1/2 LBS.	14 FT.
Flax and Millet .....	1/4"	8-1/2 LBS.	30 FT.
Ladino Clover .....	1/32"	1 LB.	28 FT.
Lespedeza.....	3/16"	6 LBS.	28 FT.
Oats .....	1"	64 LBS.	26 FT.
Orchard Grass .....	3/8"	9 LBS.	18 FT.
Rye.....	1/2"	42 LBS.	32 FT.
Sweet Sudan Grass .....	1/2"	20 LBS.	28 FT.
Timothy .....	3/16"	6 LBS.	26 FT.
Turnip Seed.....	1/4"	10 LBS.	26 FT.
Vetch.....	3/8"	40 LBS.	36 FT.
Wheat .....	1/2"	45 LBS.	32 FT.

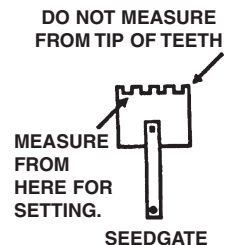

HERD SEEDER COMPANY, INC., LOGANSPOET, IN 46947

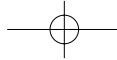

### LIMITED WARRANTY

This Herd Broadcaster was thoroughly tested before it left the factory. We warrant each Broadcaster sold by us to be free from defects in material and workmanship when used according to our directions. Our obligation under this warranty is limited to making good at the factory any defective part or parts thereof which shall, within three months after delivery of such Herd Broadcaster to the original purchaser, be returned to us. No person or company is authorized to make further warranty.

This warranty shall not apply to any Herd Broadcaster which shall have been repaired or altered outside of our factory in any way so as to affect its stability or reliability, nor which has been subject to misuse, negligence or accidents, or was caused by damage while in possession of the consumer or resulted from failure to the consumer to provide reasonable and necessary maintenance.

**DAVID E. HERD, President**  
HERD SEEDER CO., INC. - P.O. BOX 448 - LOGANSFORT, IN 46947

HERD SEEDER COMPANY, INC.  
2383 South U.S. 35, P.O. Box 448  
Logansport, Indiana 46947-0448  
Phone: 574/753-6311  
Fax: 574/722-4106  
info@herdseeder.com

